

FRONT VIEW

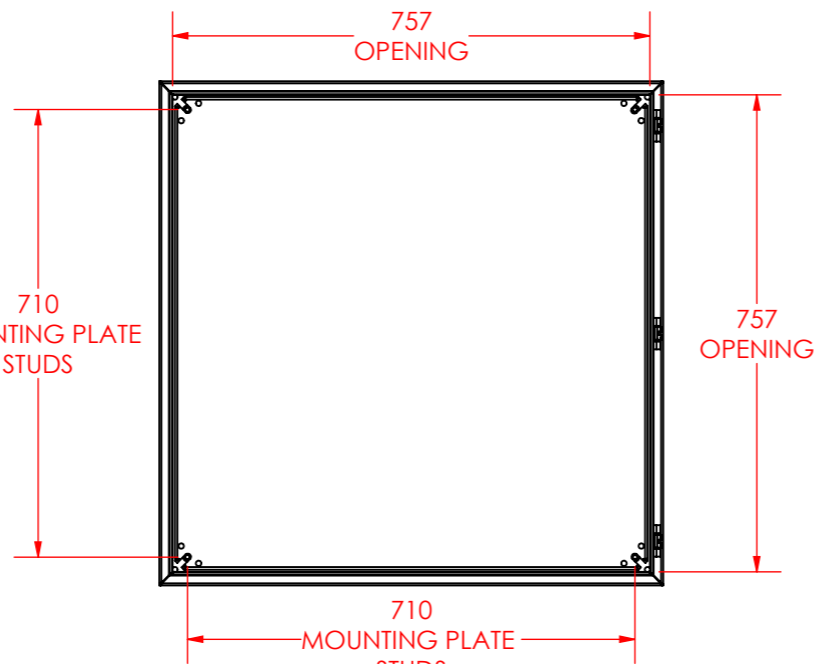

FRONT VIEW WITHOUT DOOR

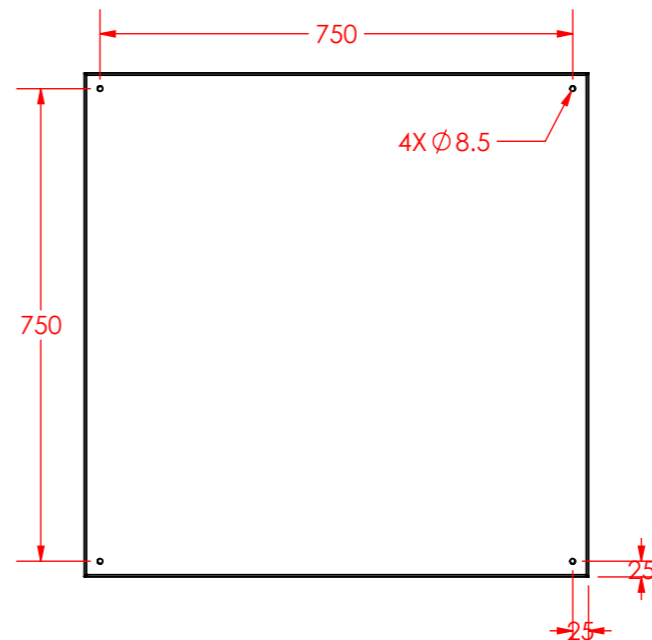

BACK VIEW

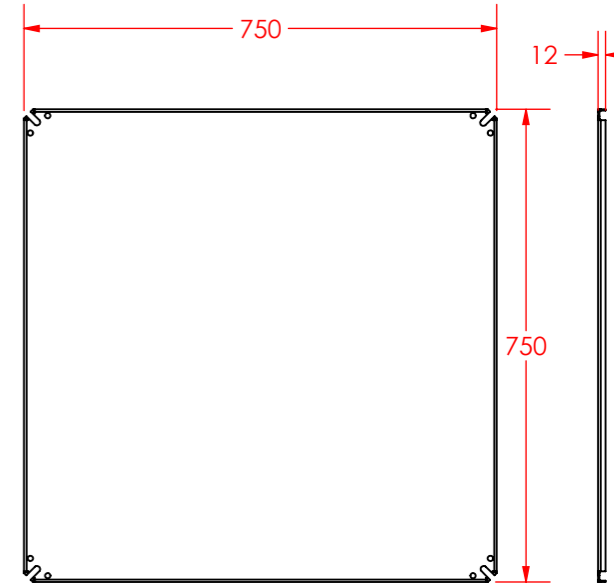

MOUNTING PLATE

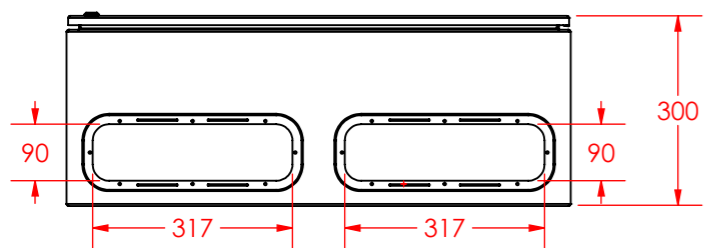

BOTTOM VIEW

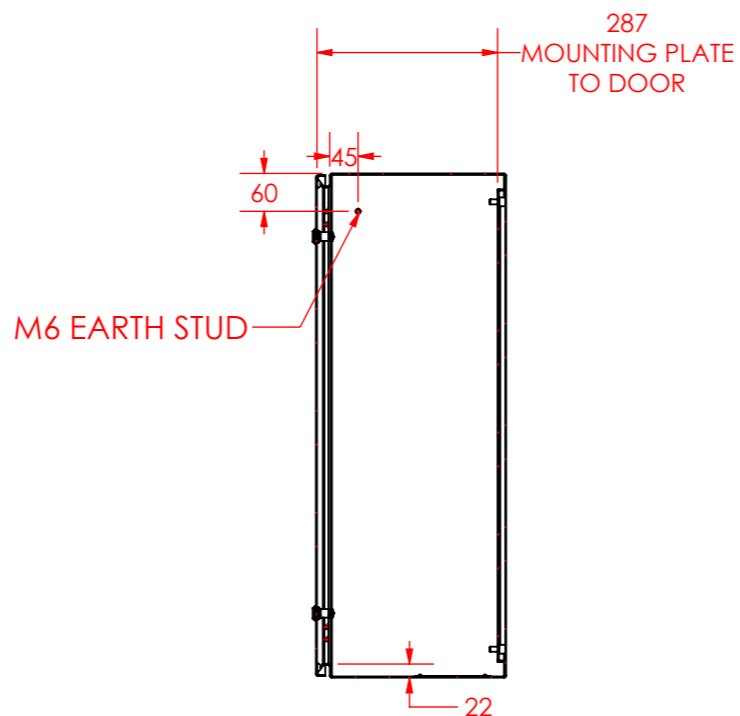

SECTION A-A
SCALE 1 : 12

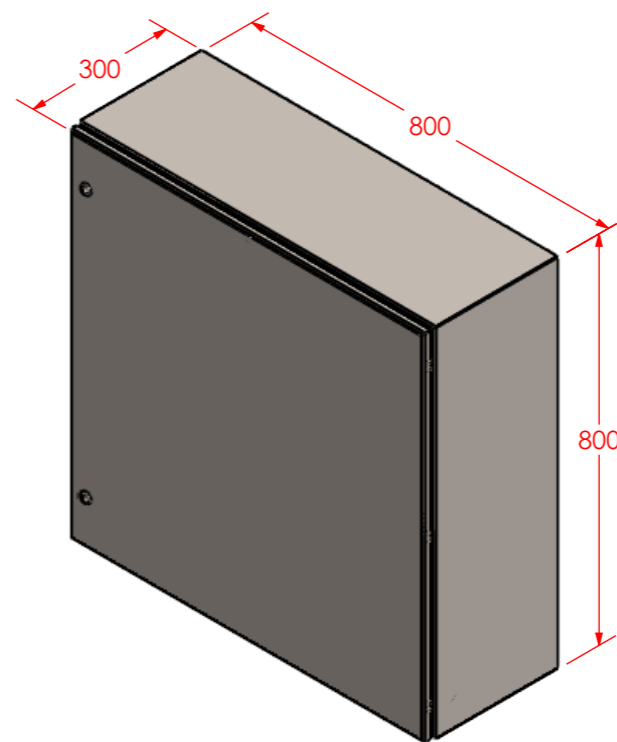

MATERIAL
BODY AND DOOR: 1.5MM 316SS
MOUNTING PLATE: 2MM GALVANISED STEEL

	DATE	01/04/2024	800x800x300 STAINLESS STEEL ENCLOSURE	
	DRAWN	E.B		
	REV	A		
ALL DIMENSIONS ARE IN MM		WEIGHT 38 KG	OSS808030	
MATERIAL: 316 STAINLESS STEEL		NOT TO SCALE	SHEET 13 OF 13	

A3