

FRONT VIEW

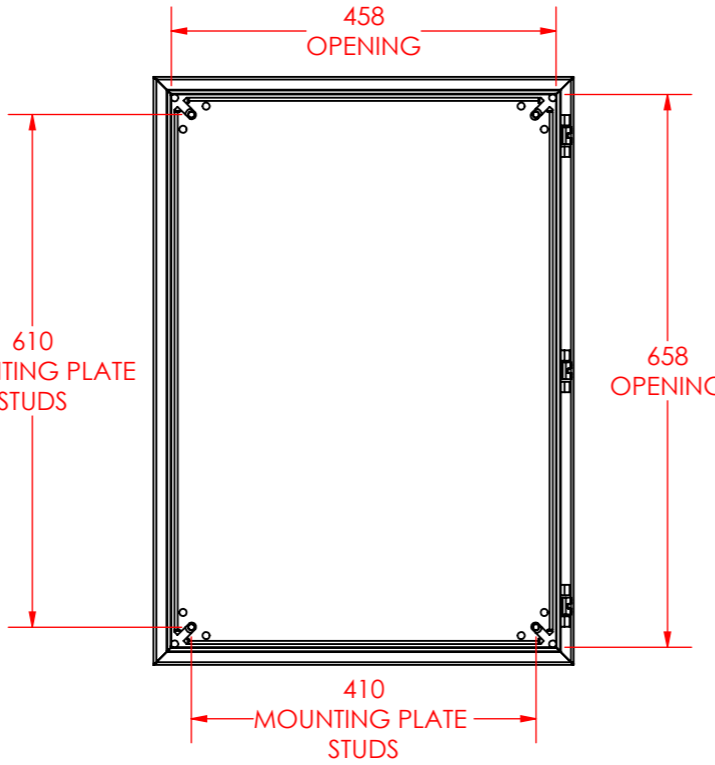

FRONT VIEW WITHOUT DOOR

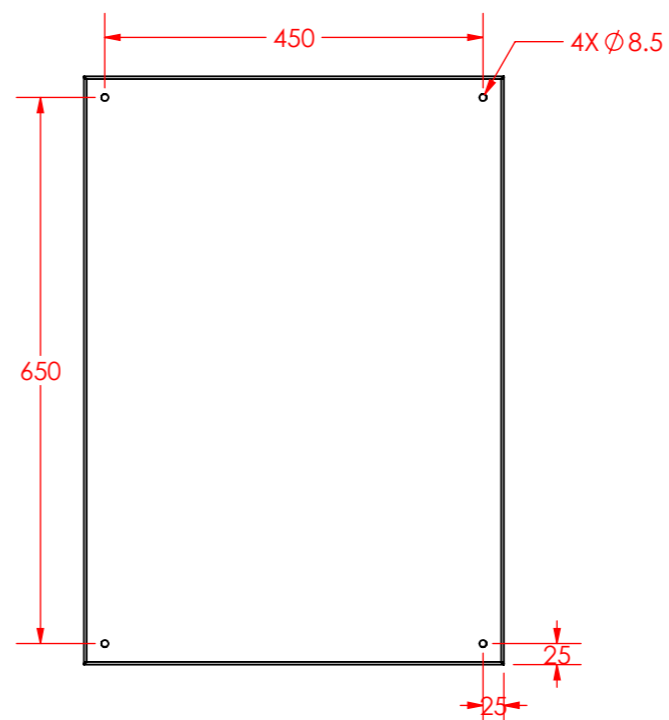

BACK VIEW

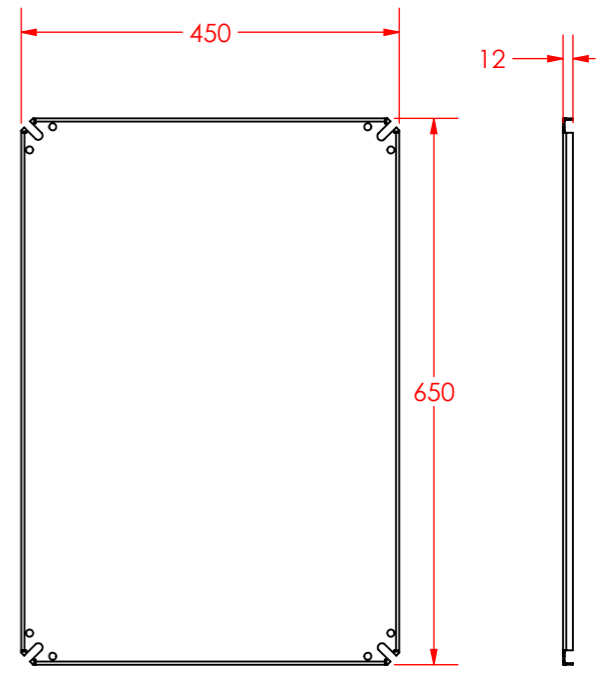

MOUNTING PLATE

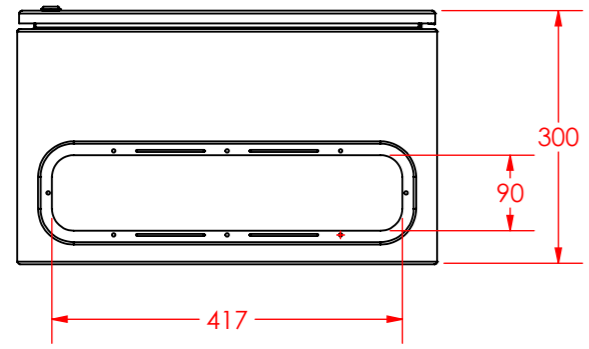

BOTTOM VIEW

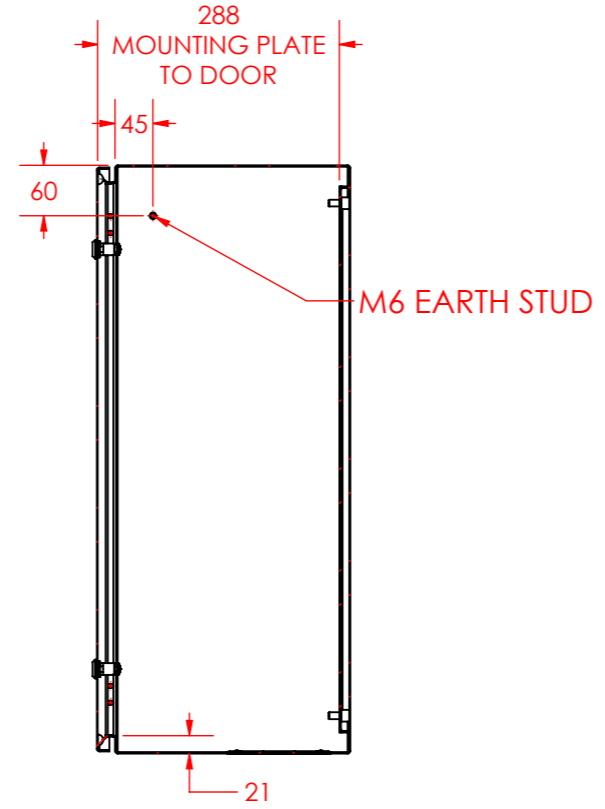

SECTION A-A SCALE 1:9

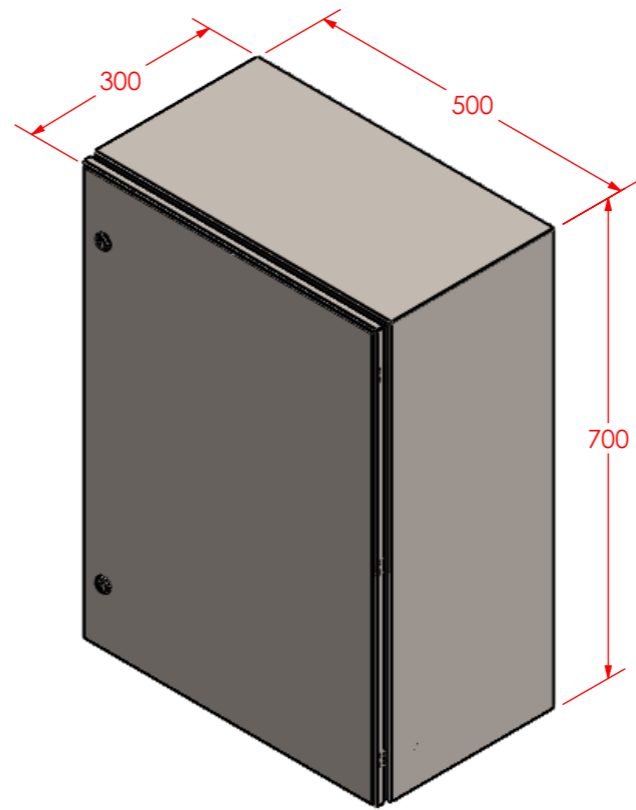

MATERIAL
 BODY AND DOOR: 1.2MM 316SS
 MOUNTING PLATE: 1.5MM GALVANISED STEEL

	DATE	01/04/2024	700x500x300 STAINLESS STEEL ENCLOSURE	
	DRAWN	E.B		
	REV	A		
ALL DIMENSIONS ARE IN MM	WEIGHT	18 KG	OSS705030	A3
MATERIAL: 316 STAINLESS STEEL		NOT TO SCALE	SHEET 11 OF 12	