

FRONT VIEW

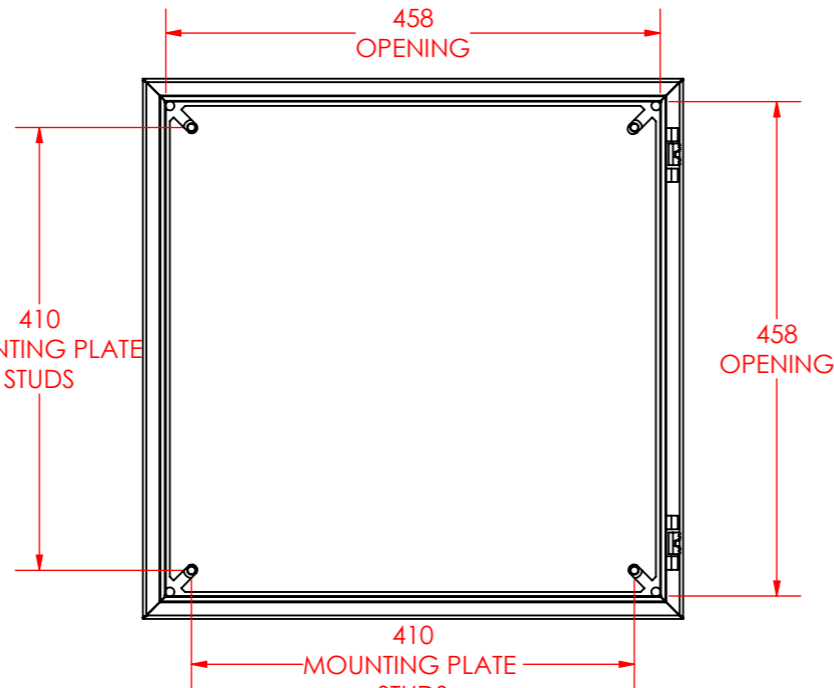

FRONT VIEW WITHOUT DOOR

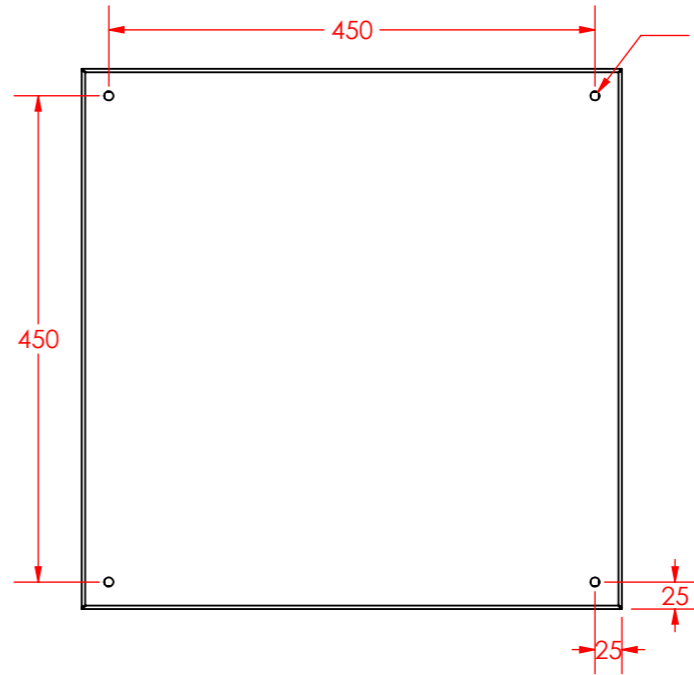

BACK VIEW

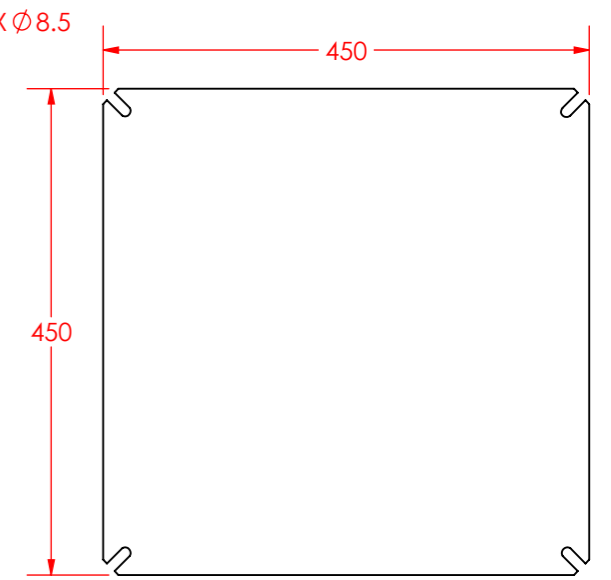

MOUNTING PLATE

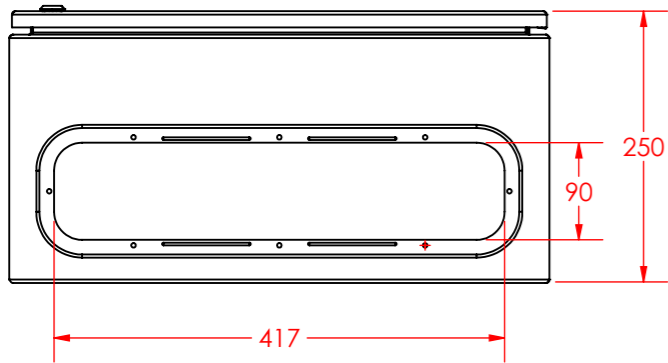

BOTTOM VIEW

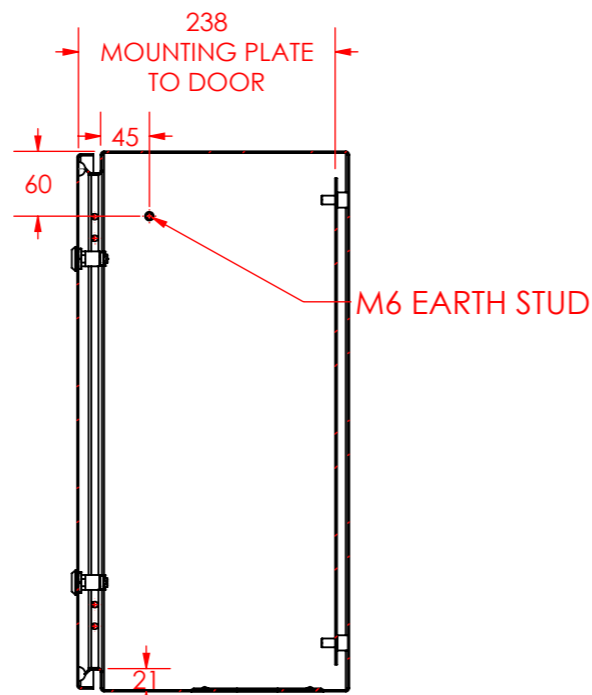

SECTION A-A
SCALE 1 : 7

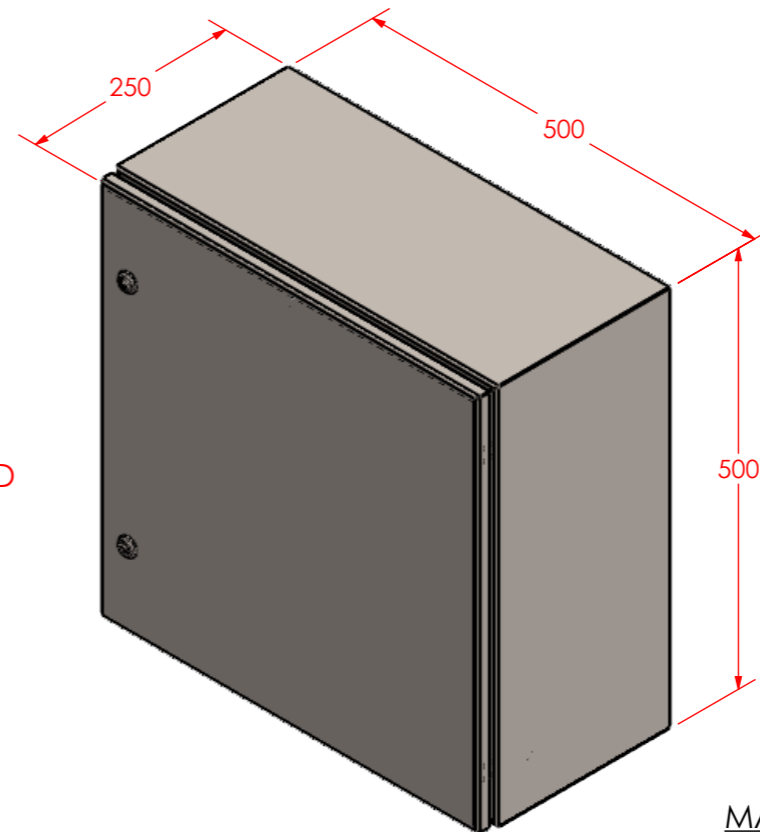

MATERIAL
BODY AND DOOR: 1.2MM 316SS
MOUNTING PLATE: 1.5MM GALVANISED STEEL

	DATE	01/04/2024	500X500X250 STAINLESS STEEL ENCLOSURE	
	DRAWN	E.B		
	REV	A		
ALL DIMENSIONS ARE IN MM	WEIGHT	14 KG	OSS505025	A3
MATERIAL: 316 STAINLESS STEEL		NOT TO SCALE	SHEET 8 OF 8	