

FRONT VIEW

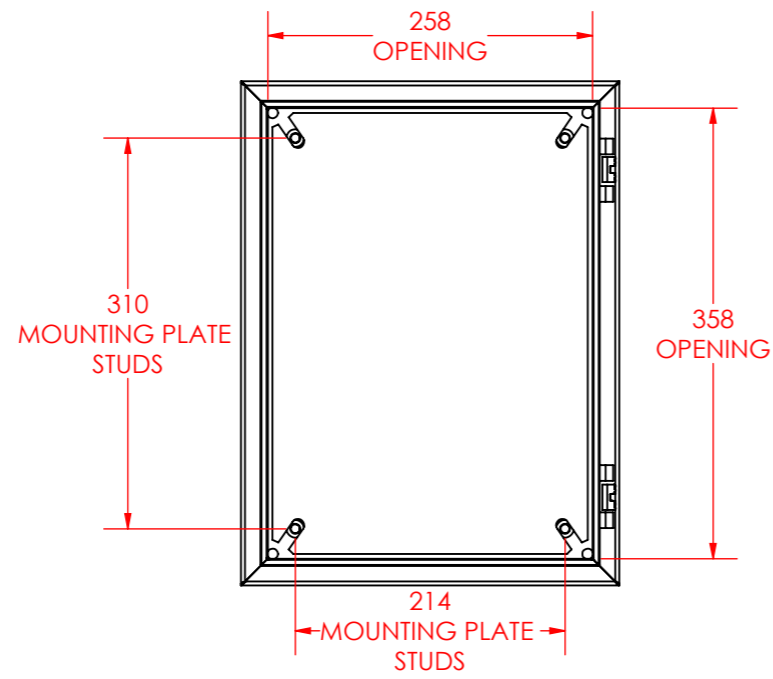

FRONT VIEW WITHOUT DOOR

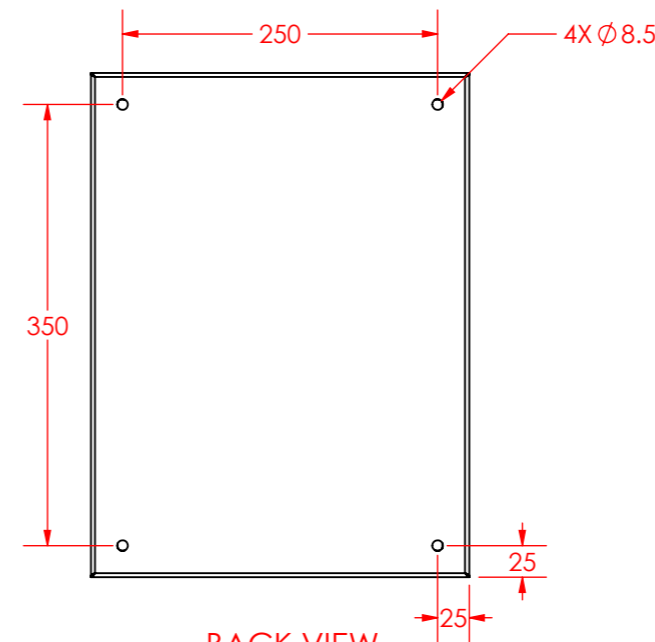

BACK VIEW

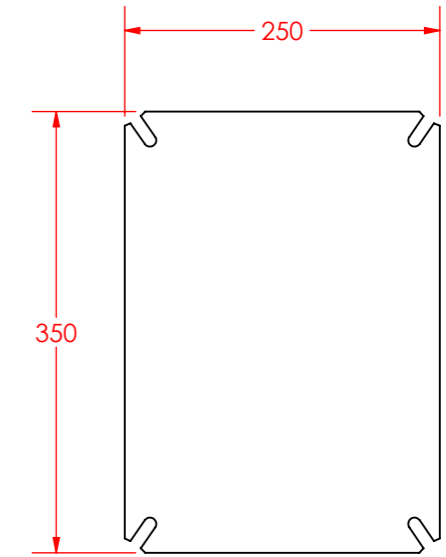

MOUNTING PLATE

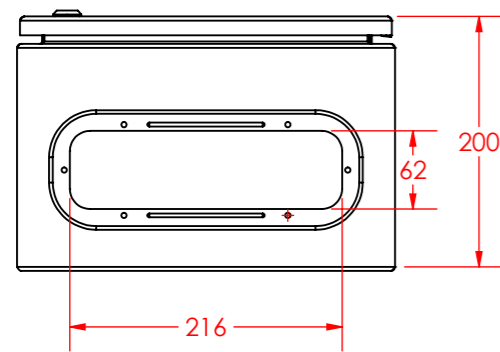

BOTTOM VIEW

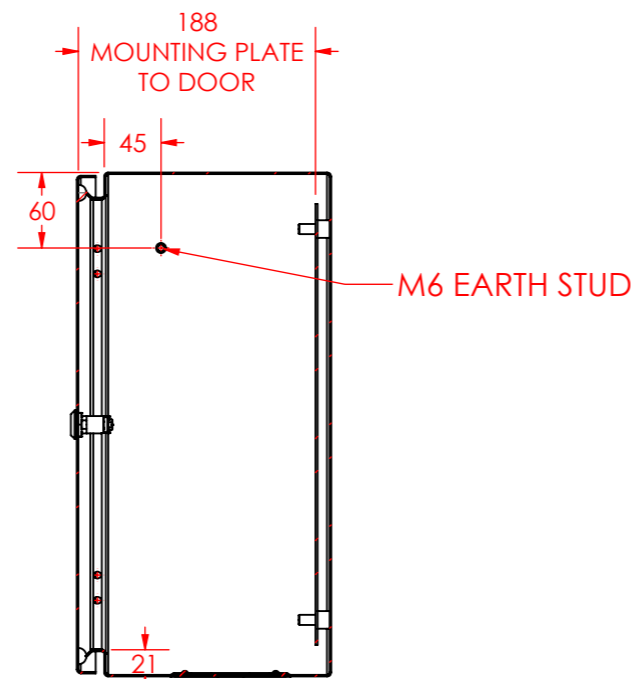

SECTION A-A
SCALE 1 : 6

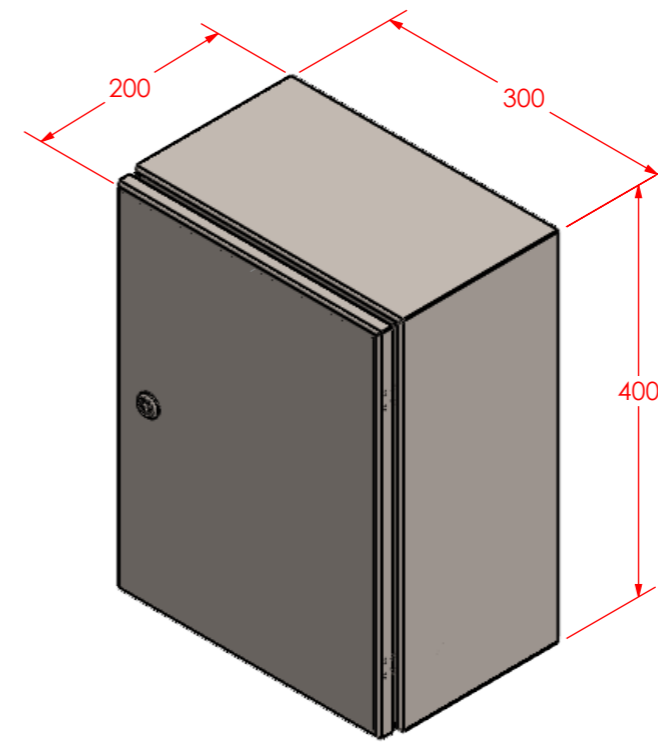

MATERIAL
 BODY AND DOOR: 1.2MM 316SS
 MOUNTING PLATE: 1.5MM GALVANISED STEEL

	DATE	01/04/2024	400X300X200 STAINLESS STEEL ENCLOSURE	
	DRAWN	E.B		
	REV	A		
ALL DIMENSIONS ARE IN MM	WEIGHT	8 KG	OSS403020	A3
MATERIAL: 316 STAINLESS STEEL		NOT TO SCALE	SHEET 5 OF 7	